

**PRODUCT DESCRIPTION**

- Bi-directional lighting
- Bendable without breaking the line of light
- Facilitates creation of geometric figures
- Large number of compatible accessories

FINISH :

Silver anodized 

Fill empty fields

Product nr.	
Fixture type	
Company	
Job name	
Date	

**TECHNICAL SPECIFICATION****Application**

- decorative lighting.

**Mounting**

- suspended using dedicated accessories.

**Additional information**

- line of light obtainable with the LIGER-22 cover and a LED tape with at least 120 LEDs per meter,
- GIZA-DUO-LL extrusion is intended for two or one 10 mm wide LED tape (for one side of the extrusion),
- two tapes provide uniform illumination of the cover over its entire width (on one side of the extrusion),
- LED tape gluing width in the profile is 22 mm,
- cover and extrusion are equally long,
- broken line of light possible with the MP-22 masking cover,
- fixtures can be suspended and powered one under another,
- can be combined into closed figures using ZM-MINI-180 connectors,
- small locks on the sides of the extrusion.

**Extrusion bending**

Minimum radius for a bent fixture
-----------------------------------

240 mm
--------

**Animation GIZA-DUO-LL**

span {font-weight:600;}

**AVAILABLE LENGTHS**

Ref. nr.	surface finish	available lengths
C2162ANODA_1	Silver anodized	39.4"
C2162ANODA_2	Silver anodized	78.75"

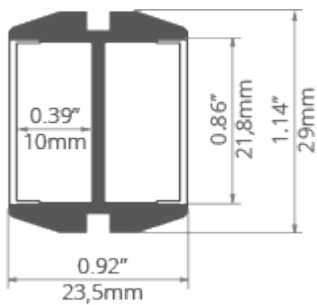
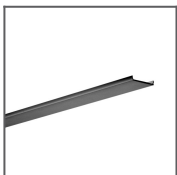
**TECHNICAL DRAWING****RELATED PRODUCTS****COVERS****BLACK**

LIGER-22 Cover  
black  
Ref: 17044

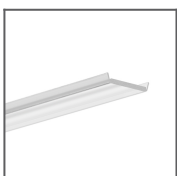
**CLEAR COVERS**

HS-22 Cover  
clear  
Ref: 17022

**FROSTED COVERS**

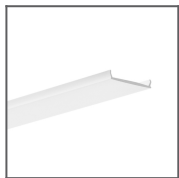

LIGER-22 Cover  
frosted  
Ref: 17032

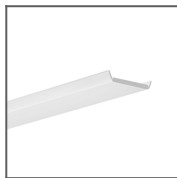

HS-22 Cover  
frosted  
Ref: 17011

## END CAPS

### REGULAR END CAPS



GIZA-DUO-LL  
grey End cap  
Ref: 24372

## ACCESSORIES

### FASTENERS & MOUNTING ACCESSORIES



BZP Head  
Ref: 42213



BZP-ZZ Head  
conductive  
Ref: 42215



OS22-PRET-Z  
Fastener white  
Ref: 42344L9010



PUSZ-PRET-ZM  
Fastener black  
Ref: 42276L9005



OS22-DUO-PRET-Z  
Fastener black  
Ref: 42343L9005



OS22-PRET-Z  
Fastener black  
Ref: 42344L9005



OS22-DUO-PRET-Z  
Fastener white  
Ref: 42343L9010



OS22-DUO-LIN-Z  
Fastener white  
Ref: 42340L9010



OS22-LIN-Z  
Fastener black  
Ref: 42341L9005



OS22-DUO-LIN-Z  
Fastener black  
Ref: 42340L9005



OS22-LIN-Z  
Fastener white  
Ref: 42341L9010



PUSZ-LIN-ZM  
Fastener black  
Ref: 42275L9005



PUSZ-LIN-ZM  
Fastener white  
Ref: 42275L9010



PUSZ-PRET-ZM  
Fastener white  
Ref: 42276L9010



PUSZ-LIN-ZM  
Fastener silver  
Ref: 42275



PUSZ-PRET-ZM  
Fastener silver  
Ref: 42276



FI-8-LIN-ZMZ  
Fastener black  
Ref: 42286L9005



FI-8-LIN-ZMZ  
Fastener silver  
Ref: 42286



FI-8-LIN-ZM  
Fastener black  
Ref: 42285L9005



FI-8-LIN-ZM  
Fastener silver  
Ref: 42285



FI-10-ZM-W  
Fastener  
Ref: 42242



FI-10-ZM-P  
Fastener  
Ref: 42244



UCHO-ZM  
Hanger  
Ref: 42512

COMPONENTS FOR CONNECTING FIXTURES

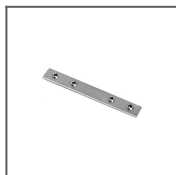

ZM-180  
Connector  
Ref: 42717



ZM-PION-120  
Connector  
Ref: 42320

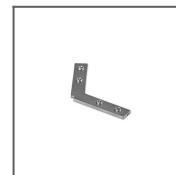

ZM-120-G  
Connector  
Ref: 42308

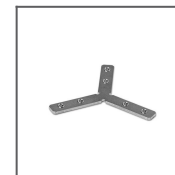

ZM-Y120-G  
Connector  
Ref: 42336

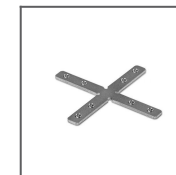

ZM-X90-G  
Connector  
Ref: 42334

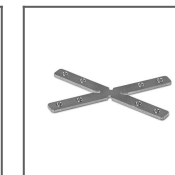

ZM-X60-G  
Connector  
Ref: 42332

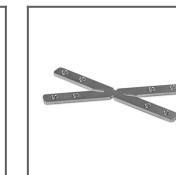

ZM-X45-G  
Connector  
Ref: 42330

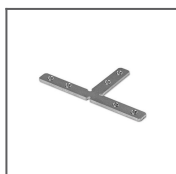

ZM-T90-G  
Connector  
Ref: 42328

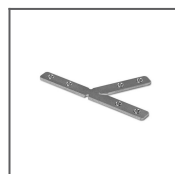

ZM-T60-G  
Connector  
Ref: 42326

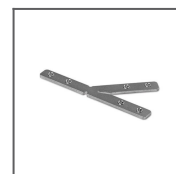

ZM-T45-G  
Connector  
Ref: 42324

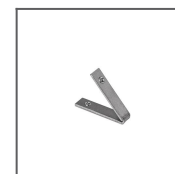

ZM-PION-45  
Connector  
Ref: 42314

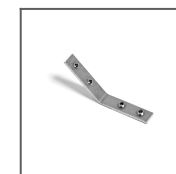

ZM-PION-135  
Connector  
Ref: 42719

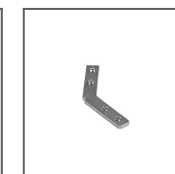

ZM-135-G  
Connector  
Ref: 42310

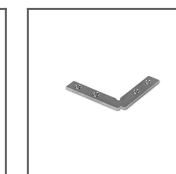

ZM-90-G  
Connector  
Ref: 42306

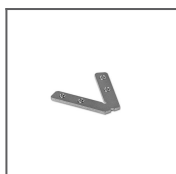

ZM-60-G  
Connector  
Ref: 42304

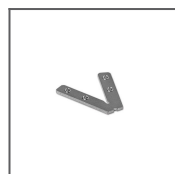

ZM-45-G  
Connector  
Ref: 42338

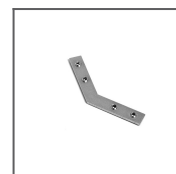

ZM-135  
Connector  
Ref: 42720

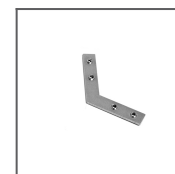

ZM-120  
Connector  
Ref: 42728

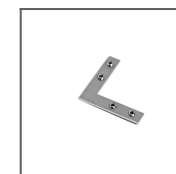

ZM-90 Connector  
Ref: 42716

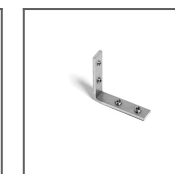

ZM-PION-90  
Connector  
Ref: 42718

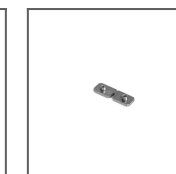

ZM-MINI-180  
Connector  
Ref: 44501

MOUNTING SETS



RG-1 Mounting  
set Silver  
Ref: 42647NI



RG-1 Mounting  
set Black  
Ref: 42647L9005

ADDITIONAL ITEMS

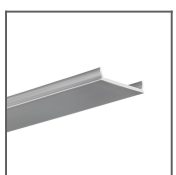

MP-22 Masking  
cover metallized  
Ref: 17167



MP-22 Masking  
cover black  
Ref: 17167L9005

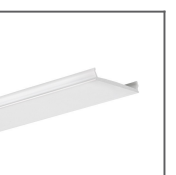

MP-22 Masking  
cover white  
Ref: 17167L9010

LED TAPES

HIGH EFFICACY



K-HE-1920-HD-24V  
Ref: K-HE-1920-HD-24V



K-HE-0960-HD-24V  
Ref: K-HE-0960-HD-24V



K-HE-1440-HD-24V  
Ref: K-HE-1440-HD-24V



K-HE-0480-HD-24V  
Ref: K-HE-0480-HD-24V

CRI95+

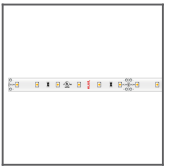

K-CR-1210-24V  
Ref: K-CR-1210-24V

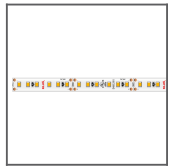

K-CR-1220-24V  
Ref: K-CR-1220-24V



K-CR-1275-24V  
Ref: K-CR-1275-24V

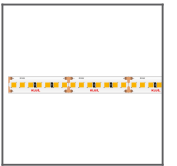

K-CR-1820-HD-24V  
Ref: K-CR-1820-HD-24V

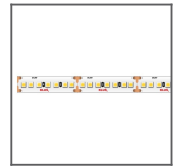

K-CR-1910-HD-24V  
Ref: K-CR-1910-HD-24V



WP-K-CR-1210-24V  
Ref: WP-K-CR-1210-24V



WP-K-CR-1220-24V  
Ref: WP-K-CR-1220-24V

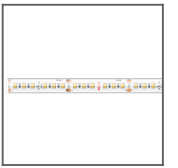

WP-K-CR-1275-24V  
Ref: WP-K-CR-1275-24V

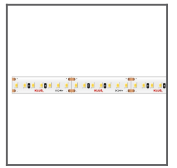

K-CR-0530-HD-24V  
Ref: K-CR-0530-HD-24V

WHITE

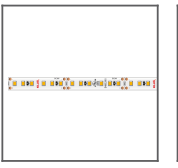

K-1220-24V  
Ref: K-1220-24

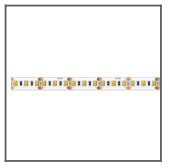

K-1275-12V  
Ref: K-1275-12

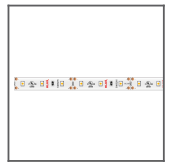

K-1210-12V  
Ref: K-1210-12

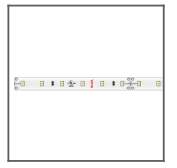

K-1210-24V  
Ref: K-1210-24

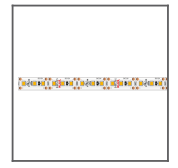

K-1220-12V  
Ref: K-1220-12

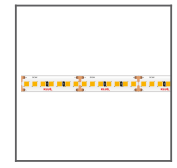

K-1820-HD-24V  
Ref: K-1820-HD-24

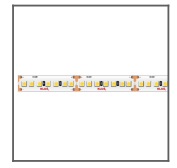

K-1910-HD-24V  
Ref: K-1910-HD-24

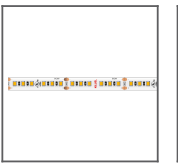

K-1275-24V  
Ref: K-1275-24



WP-K-1210-12V  
Ref: WP-K-1210-12

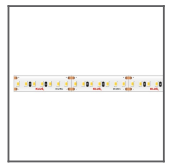

K-0530-HD-24V  
Ref: K-0530-HD-24



WP-K-1220-24V  
Ref: WP-K-1220-24

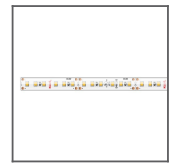

WP-K-1220-IP65-24V  
Ref: WP-K-1220-IP65-24V

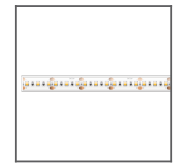

WP-K-1275-12V  
Ref: WP-K-1275-12

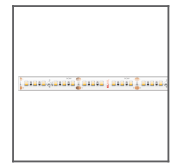

WP-K-1275-24V  
Ref: WP-K-1275-24

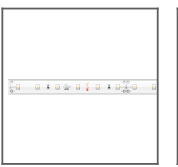

WP-K-1210-24V  
Ref: WP-K-1210-24

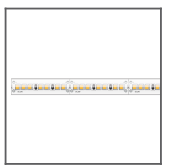

WP-K-1640-HD-IP65-24  
Ref: WP-K-1640-HD-IP65-24

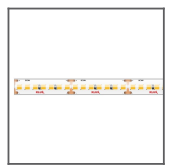

WP-K-1910-HD-IP65-24  
Ref: WP-K-1910-HD-IP65-24

RGB/ RGBW



WP-K-1275-RGB-12V  
Ref: WP-K-1275-RGB-12V



K-1920-RGB+W-24V  
Ref: K-1920-RGB+W-24V



K-1275-RGB-12V  
Ref: K-1275-RGB-12V

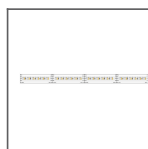

K-1530-RGB+W-24V  
Ref: K-1530-RGB+W-24V

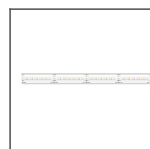

WP-K-1530-RGB+W-24V  
Ref: WP-K-1530-RGB+W-24V

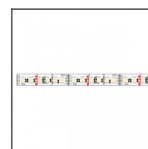

K-1920-120-RGB-24V  
Ref: K-1920-120-RGB-24V

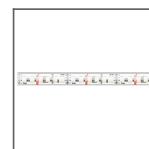

WP-K-1920-120-RGB-24V  
Ref: WP-K-1920-120-RGB-24V

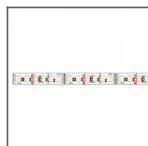

K-1200-120-RGB-24V  
Ref: K-1200-120-RGB-24V

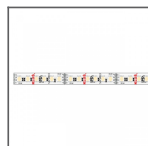

K-0700-120-RGB-24V  
Ref: K-0700-120-RGB-24V

ADJUSTABLE WHITE/ DIM TO WARM

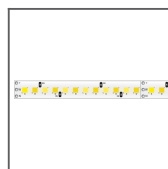

K-22/50-1728-24V  
Ref: K-22/50-1728-24V

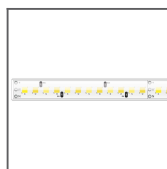

WP-K-22/50-1728-24V  
Ref: WP-K-22/50-1728-24V

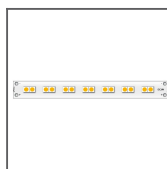

K-30/18-1770-24V  
Ref: K-30/18-1770-24V



WP-K-30/18-1770-24V  
Ref: WP-K-30/18-1770-24V

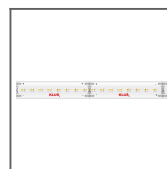

K-30/18-1770-010V-24V  
Ref: K-30/18-1770-010V-24V

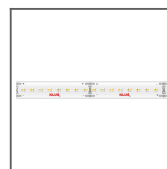

WP-K-30/18-1770-010V-24V  
Ref: WP-K-30/18-1770-010V-24V

LONG RUN



K-LR-1000-24V  
Ref: K-LR-1000-24V