

PRODUCT DESCRIPTION

- Economical end cap made of PP
- Economical T-cover with a simplified design
- Minimum dimensions for 0,5" / 14 mm strips

FINISH :

Silver anodized 

Fill empty fields

Product nr.	
Fixture type	
Company	
Job name	
Date	

TECHNICAL SPECIFICATION**Application**

For the construction of economic lighting fixtures with basic parameters.

Mounting

With mounting brackets from KLUŚ.

Additional information

- not recommended to be used with LEDs exceeding 4.5w/ft.

To obtain a fully illuminated cover (without shadows at the end caps), it is recommended to use LED strips with a maximum width of 0,39" / 10mm.

AVAILABLE LENGTHS

Ref. nr.	surface finish	available lengths
C1919ANODA_1	Silver anodized	39.4"
C1919ANODA_2	Silver anodized	78.75"

TECHNICAL DRAWING

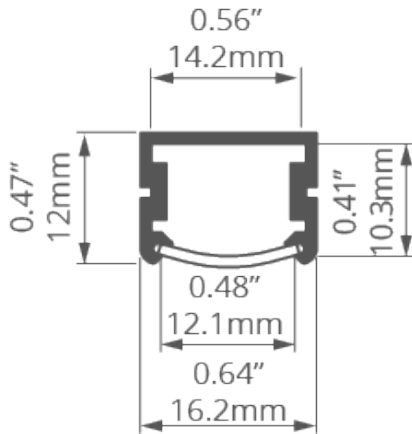

RELATED PRODUCTS

END CAPS

REGULAR END CAPS

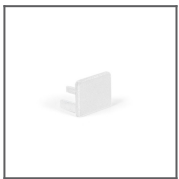

TAPO End cap
Ref: 20055

ACCESSORIES

FASTENERS & MOUNTING ACCESSORIES



PDS-STN
Mounting
bracket
Ref: 24190

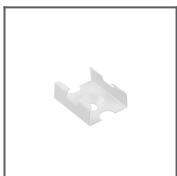

White PDS/
MICRO Mounting
bracket
Ref: 24223



Black PDS/
MICRO Mounting
bracket
Ref: 24189



REG-PD-UV
Adjustable
Mounting
bracket
Ref: 24270

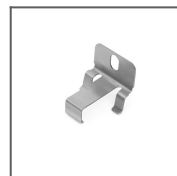

PDS-STN-90G
Mounting
bracket
Ref: 24370

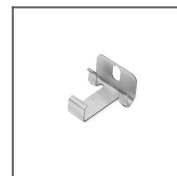

PDS-STN-90D
Mounting
bracket
Ref: 24367



ST Head
Ref: 42216



ZZ Head conductive
Ref: 42218



BZP-ZZ Head conductive
Ref: 42215



BZP Head
Ref: 42213

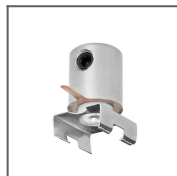

DP-MOC-ZZ Fastener
Ref: 00647



DP-MOC Fastener
Ref: 00645



DP-ZZ Fastener
Ref: 00651



FI-8-LIN-MR Fastener silver
Ref: 42287



FI-8-LIN-MR Fastener black
Ref: 42287L9005

COMPONENTS FOR CONNECTING FIXTURES

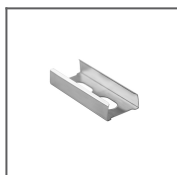

PD-MICRO Connector
Ref: 42150

MOUNTING SETS



M3 Mounting set
Ref: 42303



M4 Mounting set
Ref: 42301



M5 Mounting set
Ref: 42302

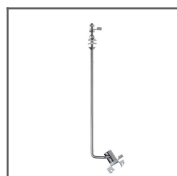

M14 Mounting set
Ref: 42612

ADDITIONAL ITEMS



6x1.2 Gland
Ref: 00802

MARKETING MATERIALS



Presentation set
6
Ref: 90125